

BOTHE-HILD®

DIE TORBAUER

ROLLTORE

MONTAGEANLEITUNG



ROLLTORE

MONTAGEANLEITUNG

SCHRITT 1

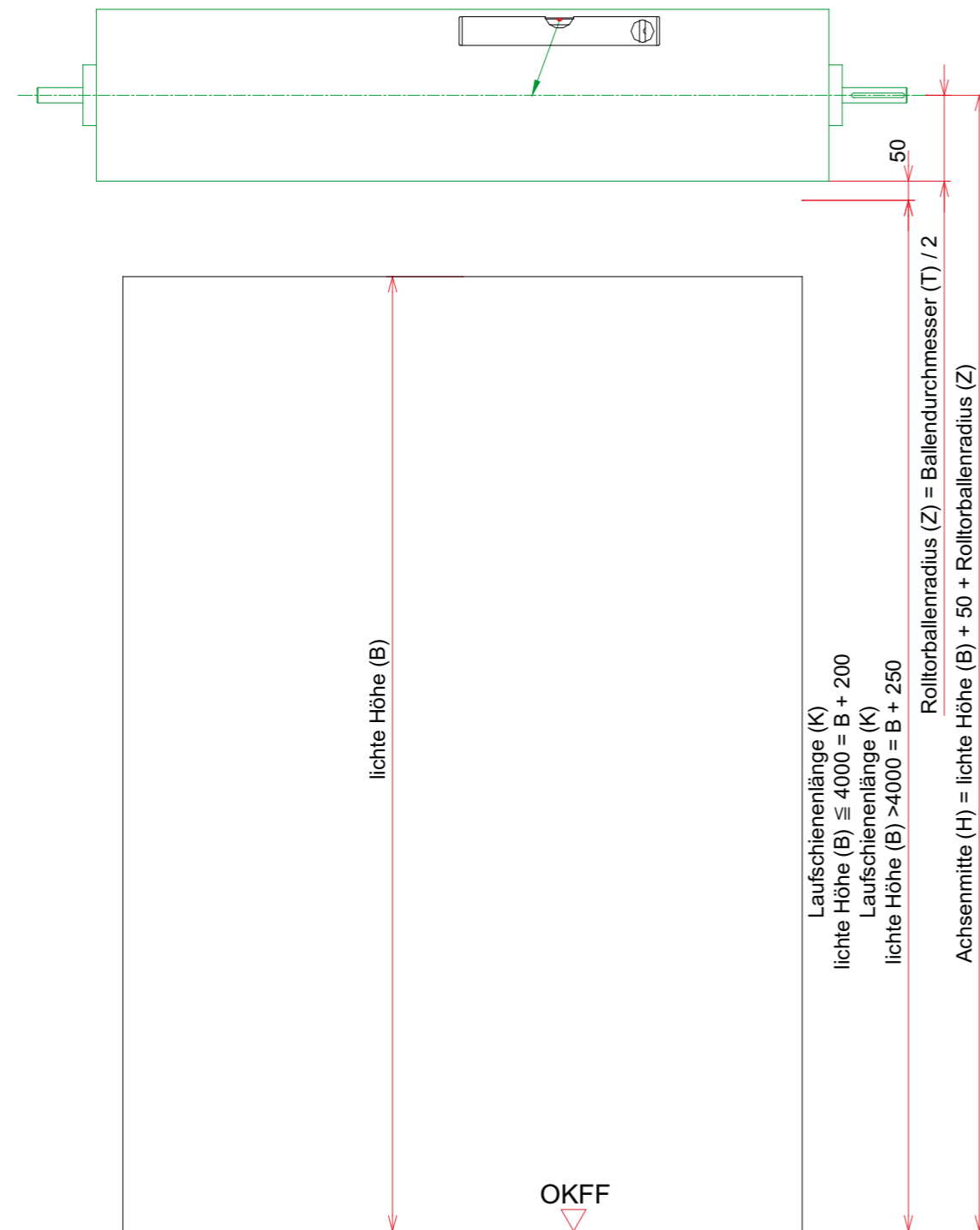

SCHRITT 2

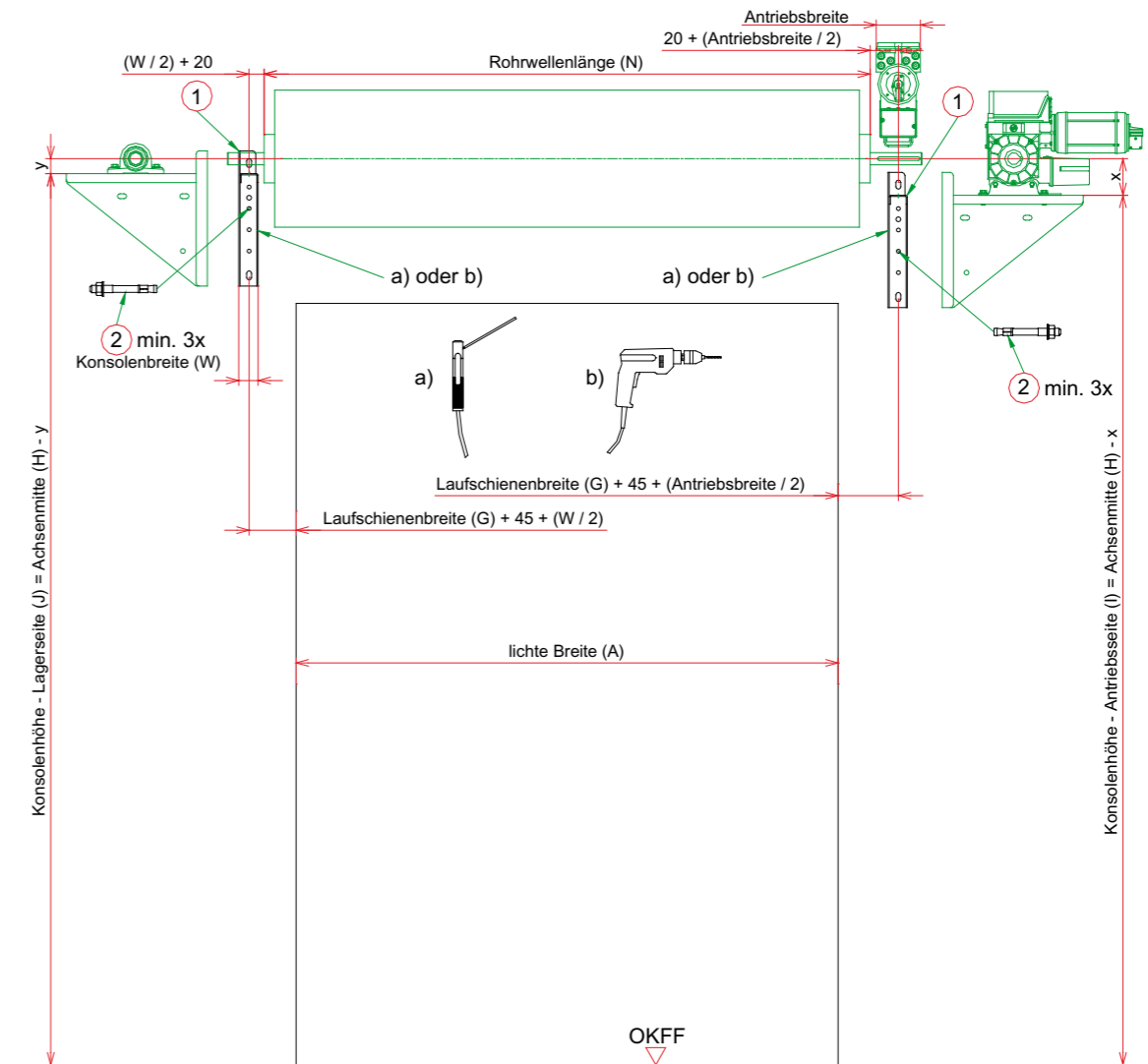

SCHRITT 3

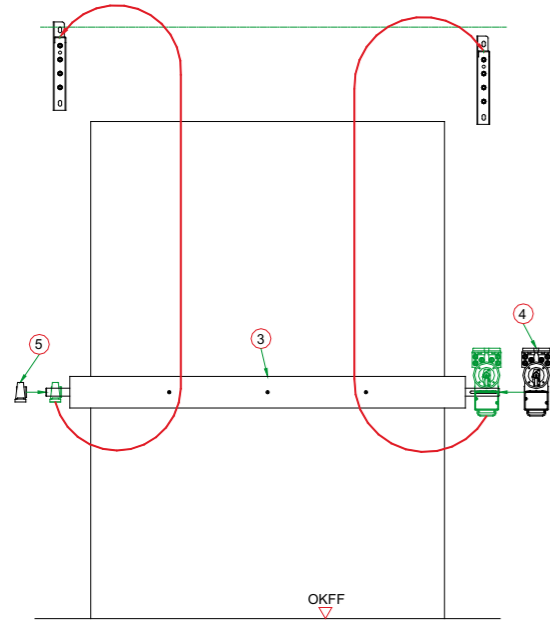

SCHRITT 5

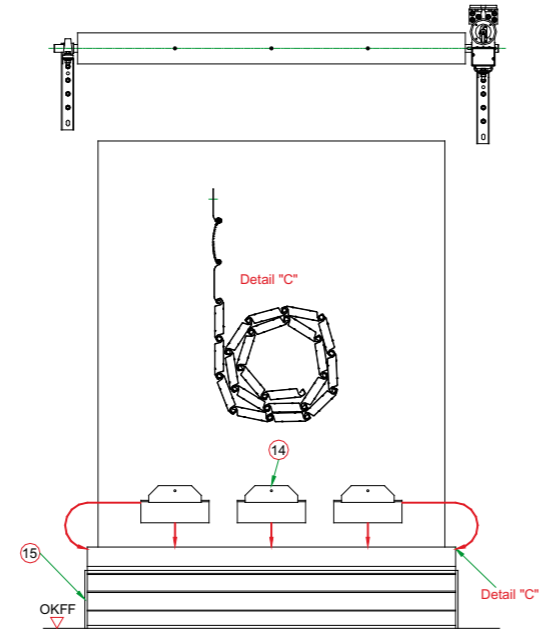

SCHRITT 4

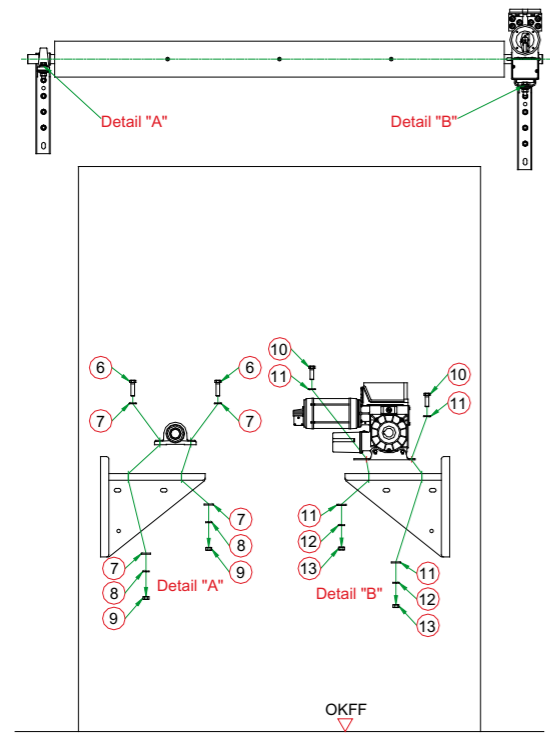

SCHRITT 6

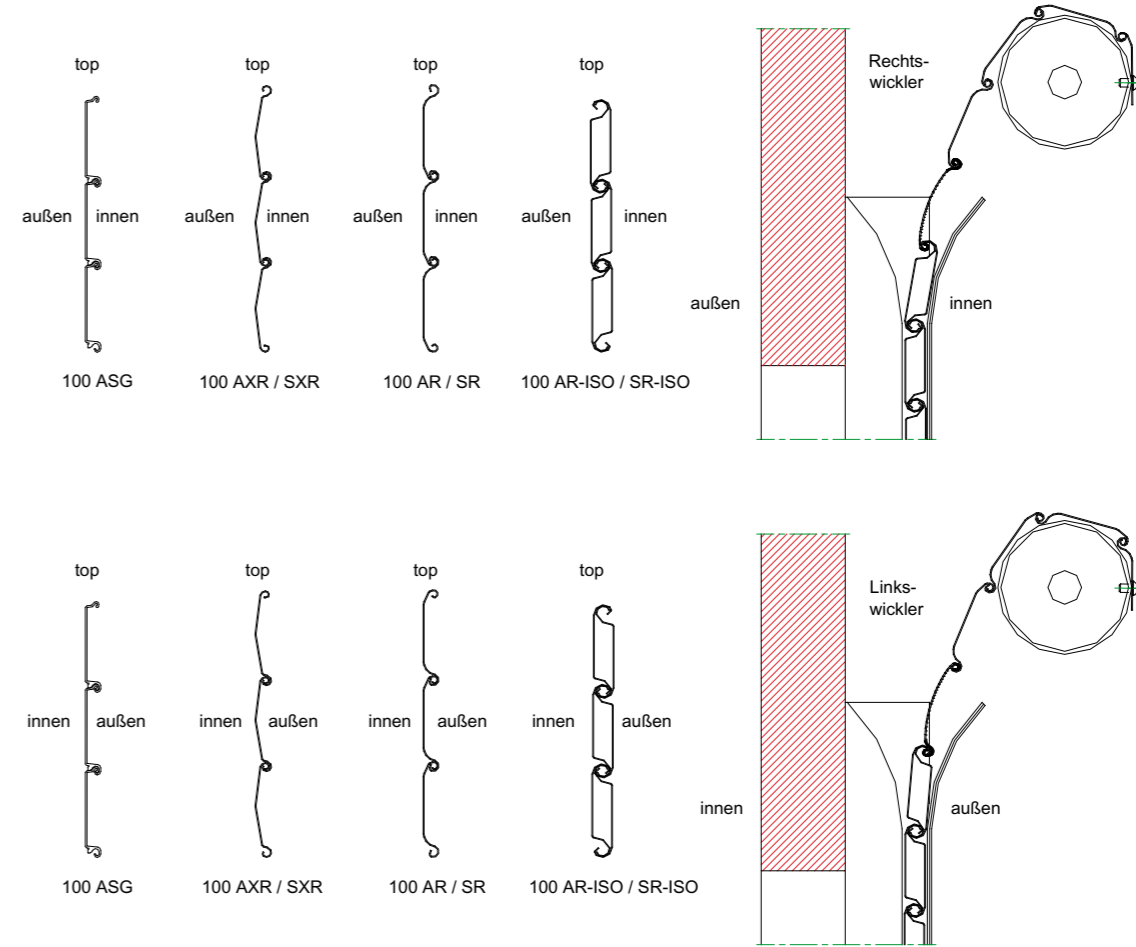

SCHRITT 7

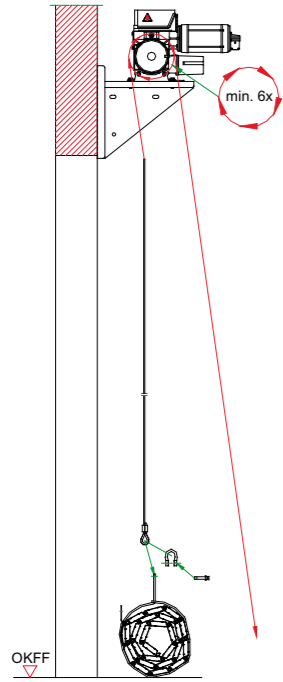

SCHRITT 9

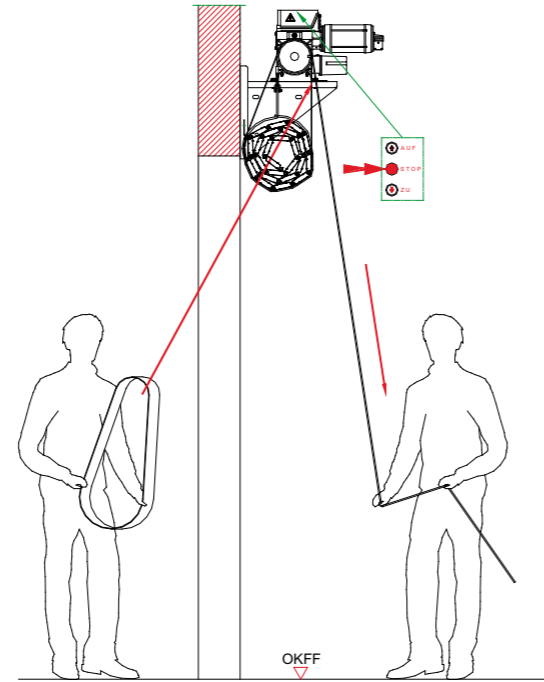

SCHRITT 11

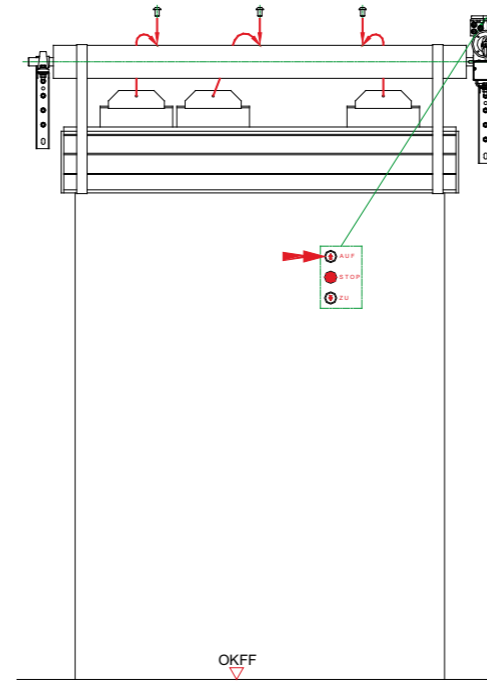

SCHRITT 13

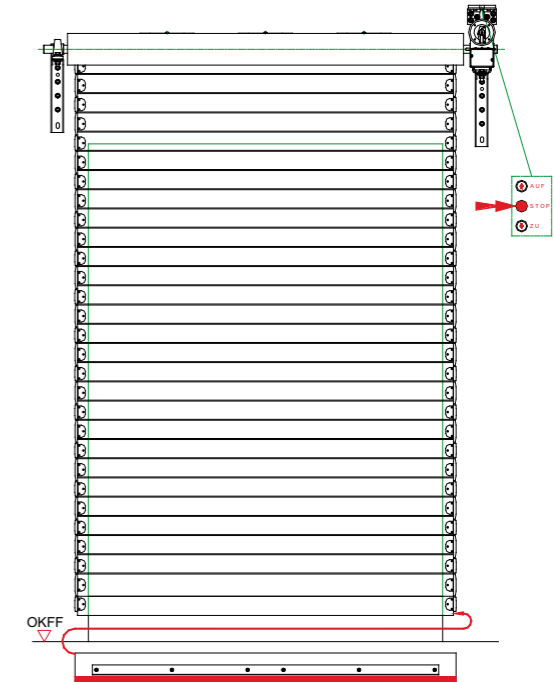

SCHRITT 8

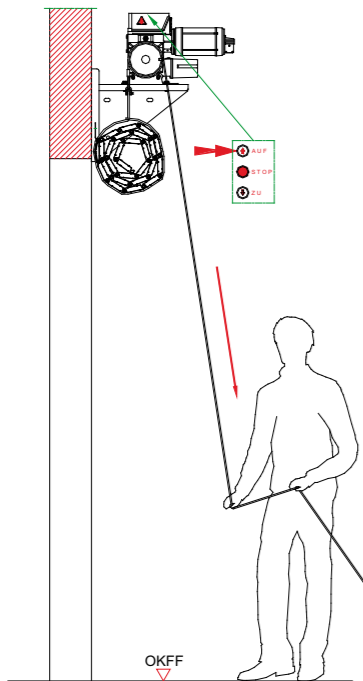

SCHRITT 10

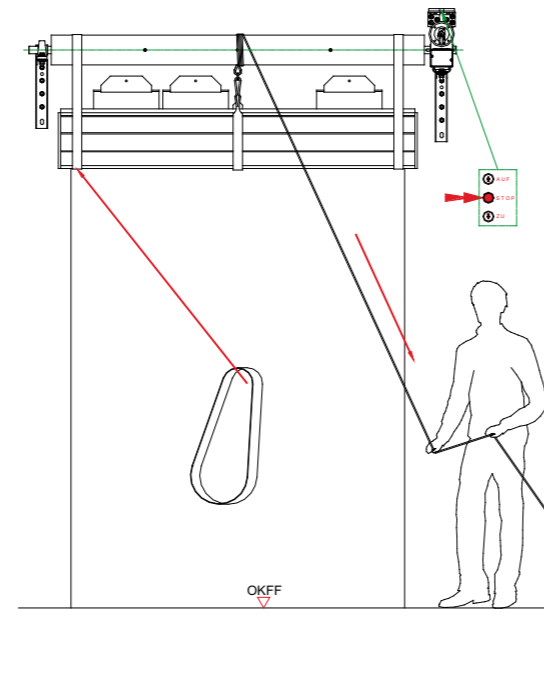

SCHRITT 12

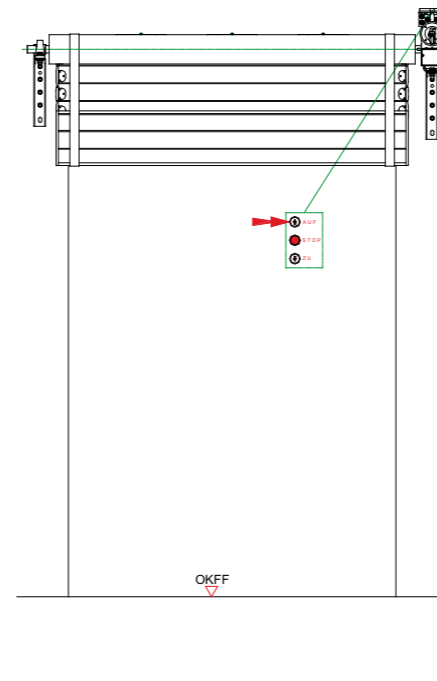

SCHRITT 14

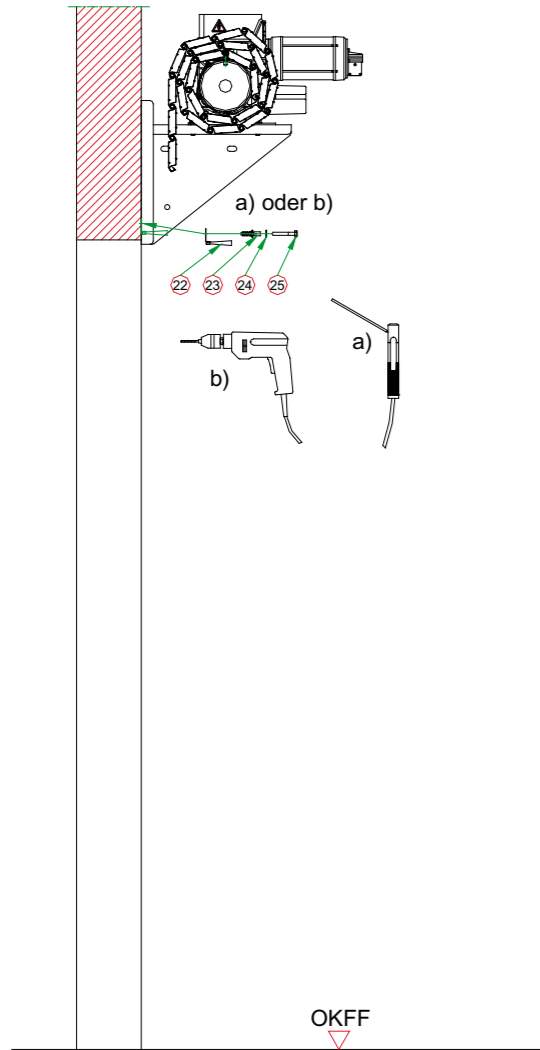

SCHRITT 15

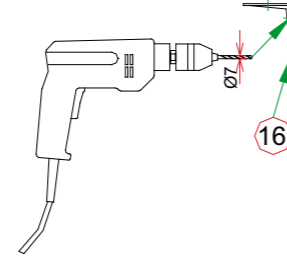

SCHRITT 16

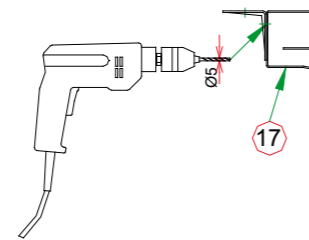

SCHRITT 17

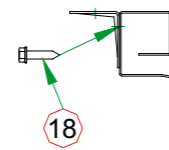

SCHRITT 18

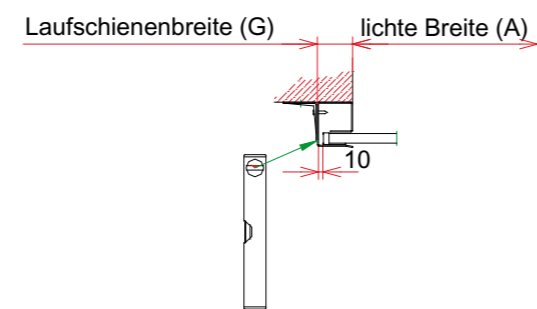

SCHRITT 19 A

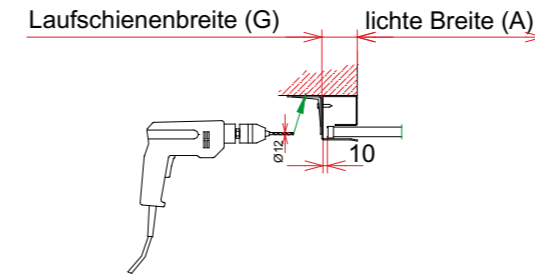

SCHRITT 19 B

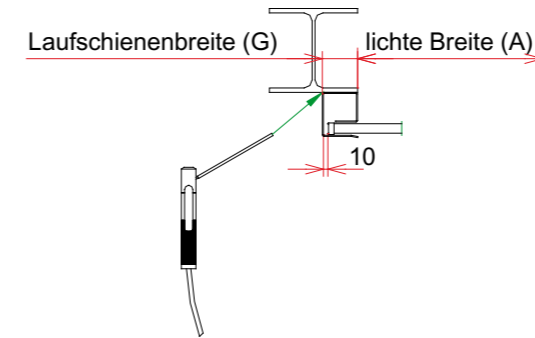

SCHRITT 20

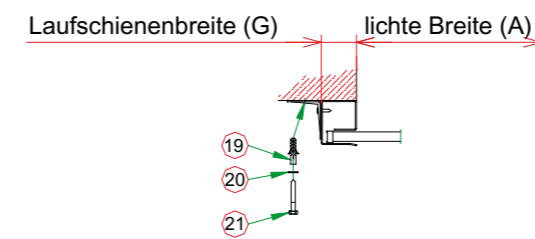

LEGENDE

Nr.	Bauteilbezeichnung	Ausführung
1	Konsole - Antrieb / Stehlager	
2	Schwerlastanker	
3	Rohrwelle	
4	Aufsteckantrieb	
5	Stehlager	
6	Sechskantschraube	DIN 933
7	Unterlegscheibe	DIN 125
8	Federring	DIN 127
9	Sechskantmutter	DIN 934
10	Sechskantschraube	DIN 933
11	Unterlegscheibe	DIN 125
12	Federring	DIN 127
13	Sechskantmutter	DIN 934
14	Aufhänger	
15	Rolltorpanzer	
16	Montagewinkel	
17	Rolltorlaufschiene	
18	Blechschrabe	
19	Nylondübel	
20	Unterlegscheibe	DIN 125
21	Schlüsselschraube	DIN 571
22	Dichtungsbürste	
23	Nylondübel	
24	Unterlegscheibe	DIN 125
25	Schlüsselschraube	

